

YP 408

DAF were already producing military cross-country vehicles before World War II.

After the war, when the existing vehicles were due for replacement, DAF, with their experience of military vehicles, were called upon to develop and build new vehicles meeting the latest tactical, military and technical requirements.

DAF's range of military vehicles includes both self-propelled vehicles and a great variety of trailers and semi-trailers.



YP 408 Armoured Personnel Carrier, 8 x 6

In the light of experience of modern tactical warfare and certain tendencies which were becoming evident at the time, there was a lively interest in new types of armoured personnel carriers for the further mechanisation of infantry at the beginning of the 1950's.

The vehicles envisaged would be able to transport infantry and mortar troops to and in the combat area rapidly, whilst ensuring that their combat value was unimpaired. If necessary, troops could go into action from the moving or stationary vehicle.

DAF developed the YP 408 on the basis of the tactical, military and technical requirements. The YP 408 was put into series production after prototypes and pre-production vehicles had been subjected to years of exhaustive testing in extreme conditions, both in the Netherlands and abroad.

The DAF YP 408 has the following features:

- Low silhouette
- Low weight
- Excellent cross-country performance
- High speeds both on and off the road
- Large operating radius
- Maximum protection against small arms fire and shell splinters
- High degree of comfort for all the occupants
- Vehicle can be driven with the hatches closed
- Easy entry and exit
- Troops can join combat from the vehicle.

The DAF YP 408 is available in the following versions:

PWI-S (GR)	Group Vehicle	PW-GWT	Ambulance
PWI-S (PC)	Platoon Commander's Vehicle	PW-V	Freight Carrier
		PW-MT	Mortar Tractor
PWCO	Company and Battalion Commander's Vehicle		

With the exception of the PW-GWT, all these vehicles are equipped with a DAF designed and manufactured ring mounting for a .50 Browning machine gun, whilst provision has been made for the installation of smoke grenade launchers at the front of the vehicle and for the installation and wiring-up of infra-red headlamps and an infra-red searchlight.

YP 408 PWI-S (PC) Version - Platoon Commander's Vehicle

This vehicle is based on the PWI-S (GR) Group Vehicle. The Platoon Commander's Vehicle is, however, equipped with more comprehensive transmitting and receiving equipment for good communication with the Group Vehicles on the one hand and the Company and/or Battalion Commander's Vehicles on the other.

The crew of the Platoon Commander's Vehicle consists of:

- 1 driver
- 1 gunner/co-driver
- 1 platoon commander
- 6 men

The men's combat equipment includes a portable anti-tank rocket gun (Carl Gustav).

A number of Group Vehicles operate under the command of the Platoon Commander's Vehicle. If necessary, a PWI-S (PC) can be converted into a PWI-S (GR) or vice versa in a few minutes. This is made possible by the fact that the two versions are provided with identical attachments inside for equipment.



YP 408 PWI-S (GR) Version - Group Vehicle

The PWI-S (GR) is the basic version.

The Group Vehicle can accommodate:

- 1 driver
- 1 gunner/co-driver
- 10 men

all with full combat equipment.

The driver and gunner are seated in the driving compartment directly behind the engine; the driver on the left and the gunner on the right.

The 10 men are seated in the crew compartment behind the driving compartment; 5 on the left and 5 on the right, face to face.

The driver and gunner can enter and leave the vehicle via the hatches above their seats or via the crew compartment and the two rear doors.

The 10 men enter and leave the vehicle via the two rear doors. In an emergency they can also leave the vehicle via the hatches in the roof of the crew compartment.

The driver's seat can be adjusted vertically and locked in position. In the high position the driver's head projects above the hull through the open hatch. In the low position, when the hatch is closed, the driver has two fixed periscopes and one rotating periscope at his disposal for driving and observation purposes. With the seat in the high position the driver is protected against the weather on non-active service by a canvas cover with a window and window wiper. This cover can be folded out of the way in a minimum of time. The seat for the gunner/co-driver is not adjustable, being fixed in the low position. When the vehicle is being driven with closed hatches he sits on the seat, whilst during observation and/or in action he stands on the seat. A wide canvas strap is provided to give the gunner/co-driver a raised seating position when the hatches are open. Two fixed periscopes are fitted in front of the gunner/co-driver for observation purposes.

Two rows of five seats are provided in the crew compartment. The hinged seat backs can be folded horizontal to serve as raised seats. In such a

case the actual seats are tipped up to give more leg room.

There are six hatches in the roof of the crew compartment, three on either side. They can be opened or closed, independently of each other, from inside.

The two rear doors are of generous dimensions for rapid entry and exit. The doors can be opened from both inside and outside the vehicle, and they are locked in the open position.

The interior of the vehicle is equipped with a large number of boxes, racks, clamps and straps for ammunition, general equipment, radio transmitting and receiving equipment, spare periscopes, spare machine gun barrel, fire extinguisher, first aid box, etc. On the outside of the vehicle a pioneer rack and straps for holding camouflage nets are provided.

The vehicle is also equipped with a heating system, masked interior lighting, observation slits in the rear doors and outside tool boxes.





**YP 408 PWCO Version
Company Commander's Vehicle - Battalion Commander's Vehicle**

The PWCO version fully meets the tactical requirements of a command post at company or battalion level.

At the front of the crew compartment there is comprehensive radio transmitting and receiving equipment for contact with the senior command, the units operating at company and battalion levels and the other PWCO vehicles. The interior of the crew compartment is specially equipped for this purpose, being fitted, inter alia, with a tip-up table, a map shelf, storage compartments and bags, fluorescent lighting, etc.

The PWCO is manned by:

- 1 driver
- 1 gunner/co-driver
- 1 company or battalion commander
- 3 men

Since the PWCO vehicle is in stationary use more frequently and for longer periods than the other versions, it is fitted with a heater working independently of the vehicle engine. This heater, which runs on diesel oil from the fuel tanks, is located in the crew compartment.

When the Command Vehicle is in a stationary position in the area of operations, a tent forming part of its equipment can easily be attached to the rear of the vehicle.

A flexible exhaust pipe extension, likewise forming part of the vehicle equipment, can be fitted when the vehicle is deployed in a stationary position with the engine running, to avoid exhaust gases entering the interior of the vehicle. The electrical system includes a 3 kVA alternator and two additional batteries to allow for the higher current consumption caused by the radio equipment, heater and fluorescent lighting.





YP 408 PW-GWT Version - Ambulance

Though basically identical with the other versions, the PW-GWT has an interior layout specially designed for the transportation of wounded soldiers and a two-piece hatch instead of a ring mounting for a .50 machine gun. On the left-hand side of the crew compartment there is a frame to hold two standard NATO stretchers.

The stretcher frame is pivot-mounted at the front and hung on two hooks at the rear. This pivot mounting permits the stretcher frame to be swung over towards the door opening, enabling the stretchers to be slid in or out in the minimum of time.

The stretcher frame is locked in position to prevent fore and aft or lateral movement while the vehicle is being driven.

The crew consists of:

- 1 driver
- 1 medical orderly/co-driver
- 1 medical orderly

The vehicle can carry:

- 2 recumbent patients
- 4 sitting patients

The PW-GWT is fitted with radio transmitting and receiving equipment. Spare stretchers are carried on the outside of the hull on the left rear side of the vehicle.





YP 408 PW-V Version - Freight Carrier

The PW-V version is intended for carrying essential freight to and in the area of operations.

For this purpose the freight compartment is provided with a floor consisting of five pivoted, removable sections and closing off the bottom of the hull.

The crew consists of:

- 1 driver
- 1 gunner/co-driver

The driver's department and freight compartment are separated by a grille to protect the driver and gunner against sliding loads. A forward-opening gate in the grille enables the crew to leave the vehicle via the rear doors, if necessary.

The PW-V can carry 1500 kg of freight. The vehicle is also suitable for carrying wounded soldiers. Accommodation for eight sitting patients is provided by tipping up some of the floor sections. With all the sections folded down three recumbent patients can be carried on the floor.

The fixed interior equipment of the PW-V Freight Carrier is identical to that of the PW-GWT Ambulance.

A PW-V can be converted into a PW-GWT or vice versa in a few hours, provided, of course, that all the necessary equipment is available.

Unlike all the other versions of the YP 408, the PW-V is not fitted with radio transmitting and receiving equipment.





YP 408 PW-MT Version - Mortar Tractor

The Mortar Tractor version of the YP 408 was developed principally for pulling the 120 mm BRANDT-RAYE mortar.

A special rack is provided in the crew compartment for about 50 mortar shells. The shells remain in position in the event of emergency braking or a collision; there is thus no risk of their being thrown to the front of the crew compartment or into the driver's compartment.

The crew consists of:

- 1 driver
- 1 gunner/co-driver
- 1 mortar group commander
- 4 men

The mortar group commander is seated directly behind the driver, whilst the four men are accommodated between the shell rack and the rear doors.

The rear doors are of a different design from those of the other versions of the YP 408. They have been shortened at the bottom, so that they can still be opened and closed when a mortar is hooked up. The space at the bottom is closed off by means of a hinged tailgate which can be opened to a horizontal position.



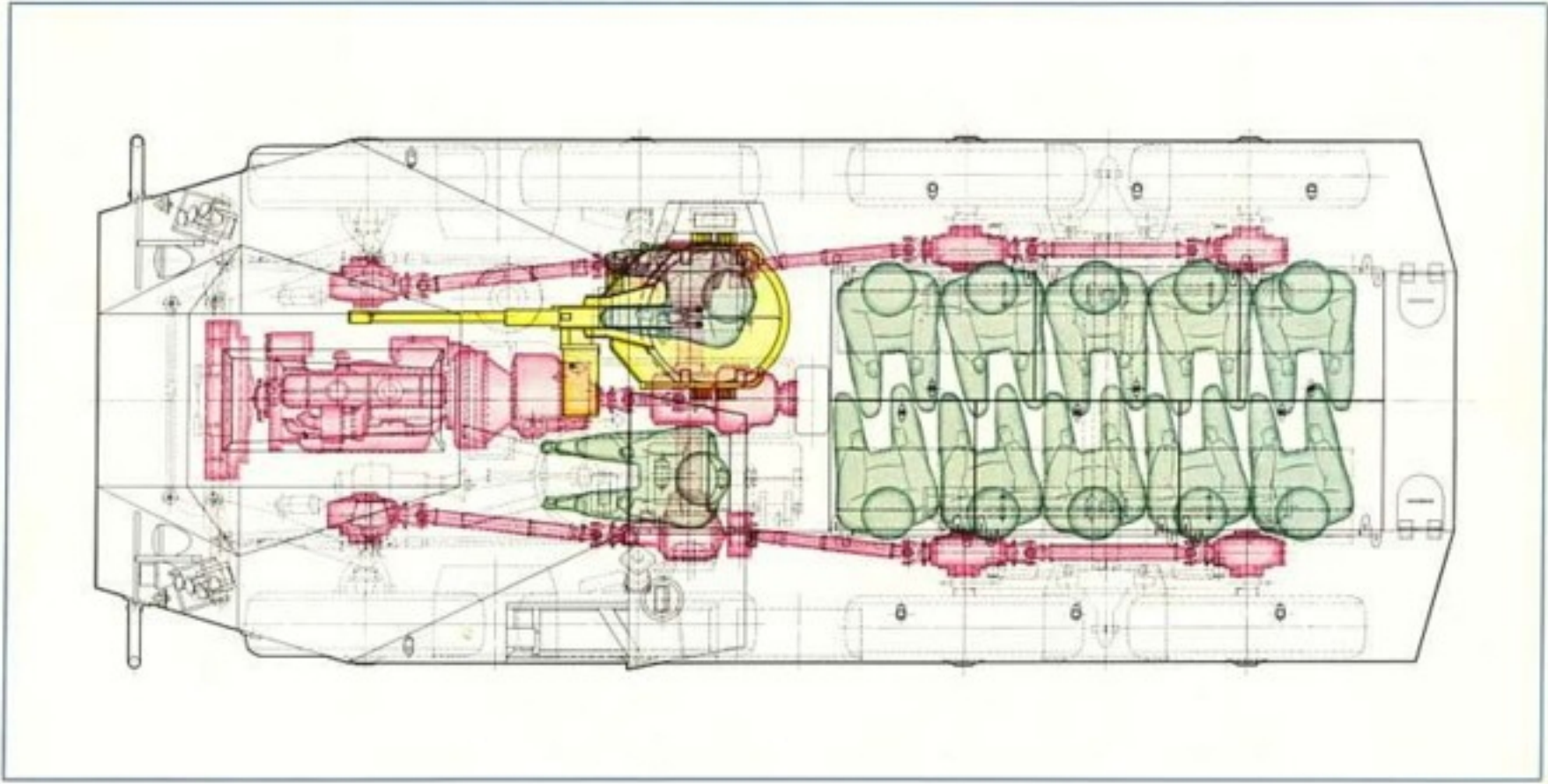

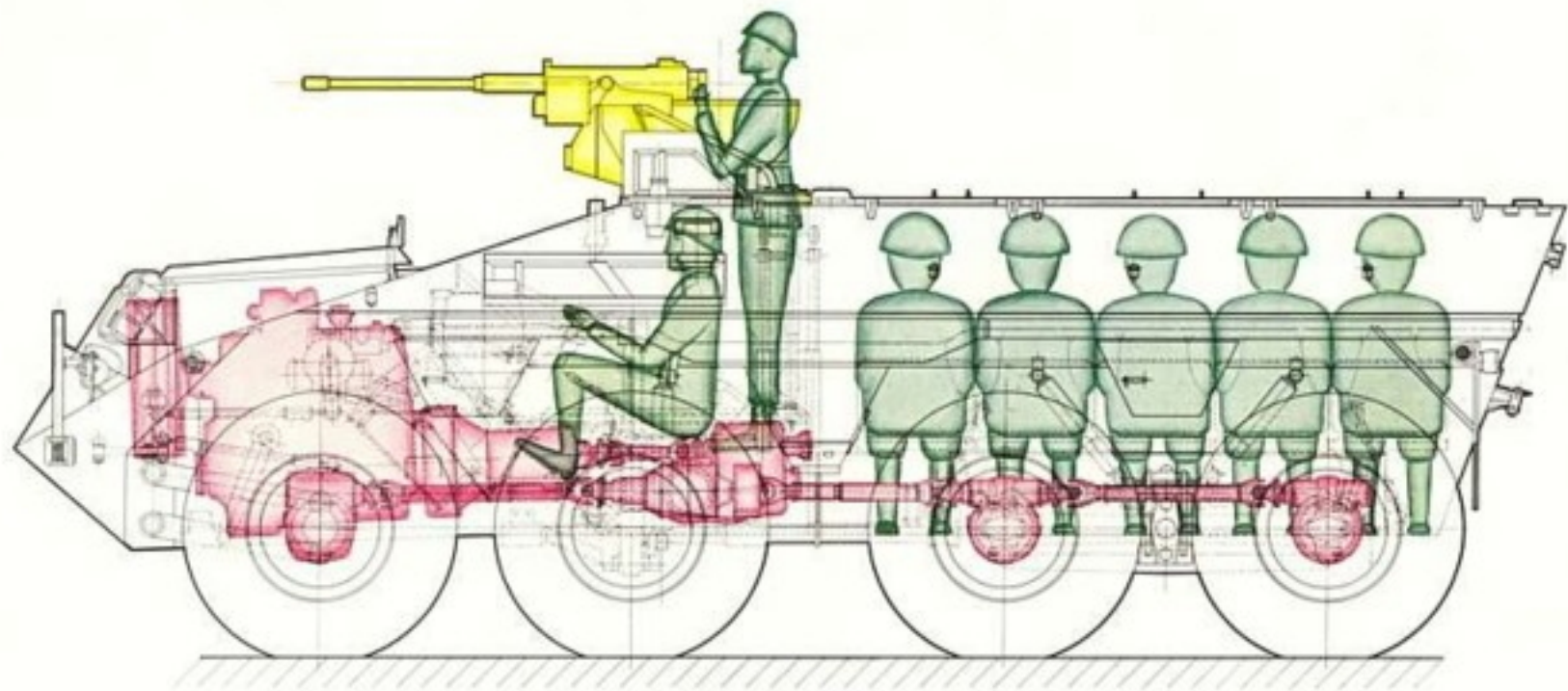

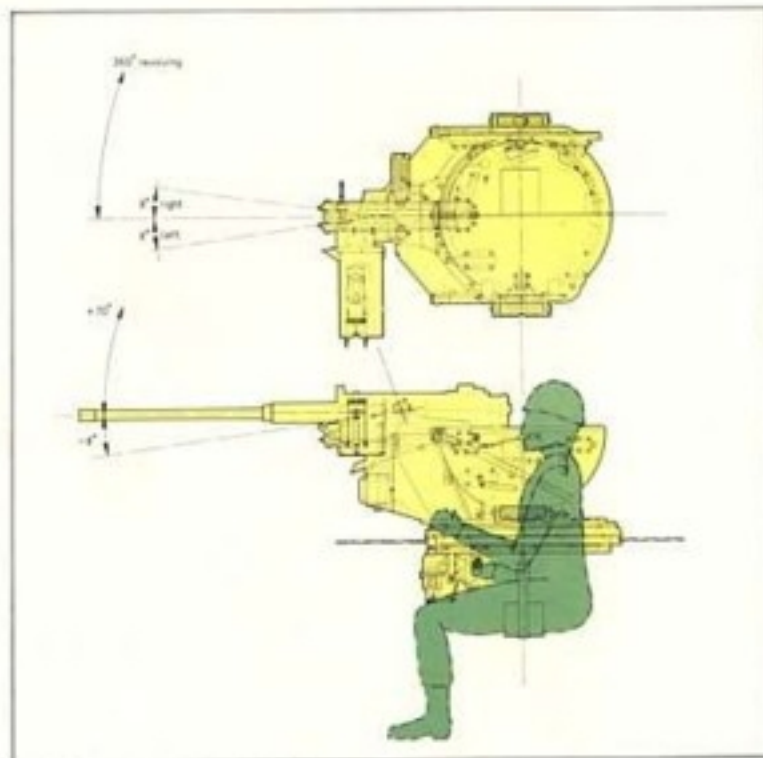

Machine Gun Mounting

The DAF designed and manufactured gun mounting for a .50 BROWNING machine gun on the hull consists of a ball bearing with ring gear and pinion, a gun cradle and a pair of hatch plates which are raised to a vertical position to protect the gunner.

The gun mounting can be turned through 360° with a handwheel or the gunner's shoulder.

The cradle is designed to keep the gun in balance and to enable the gunner effortlessly to determine elevation and inclination.

The machine gun mounting can be locked in position for firing or while the vehicle is in motion.

General Specification

Unladen weight	approx. 9500 kg
Laden weight	approx. 12000 kg
Weight class	10
Max. axle load:	
1st front axle	3500 kg
2nd front axle	2500 kg
Rear tandem axle	6000 kg
Wheelbase	3400 mm
Track, front	2054 mm
Track, rear	2080 mm
Operating range, on the road	500 km
Operating range, off the road	400 km
Fuel consumption, on the road	1 litre per 2.25 km
Cruising speed	60 km/hr
Max. speed in "High" range	80 km/hr
Max. speed in "Low" range	35 km/hr
Min. running speed	4 km/hr
Operating temperature range	-26°C to + 50°C
Freighting dimensions	2.40x2.40x6.23 m
Freighting volume	approx. 36 m ³

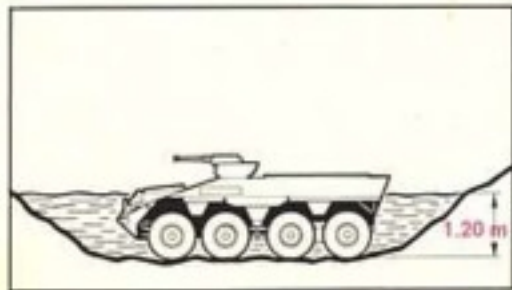
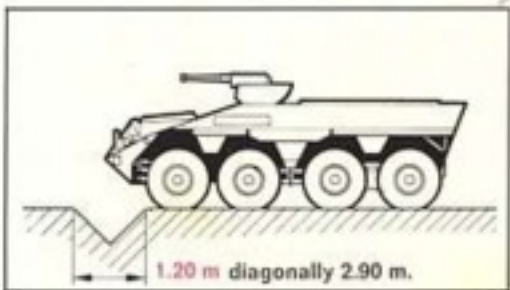
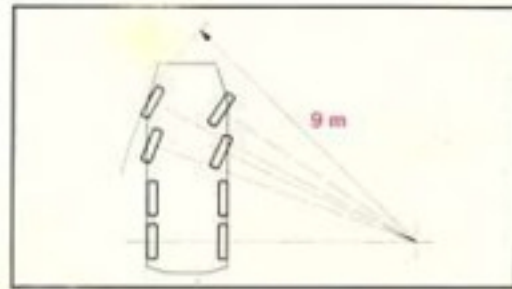
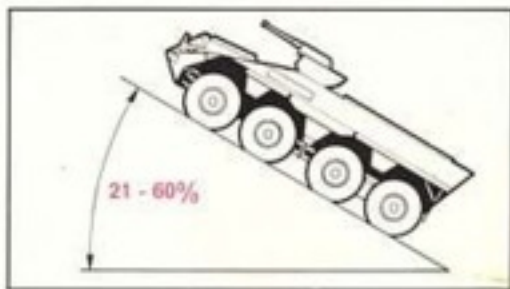
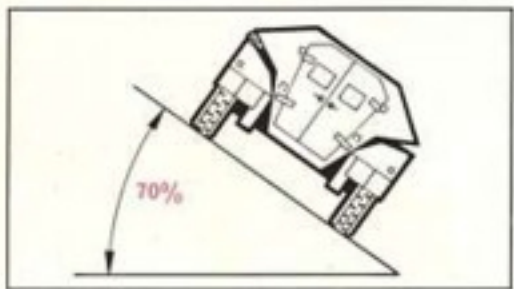
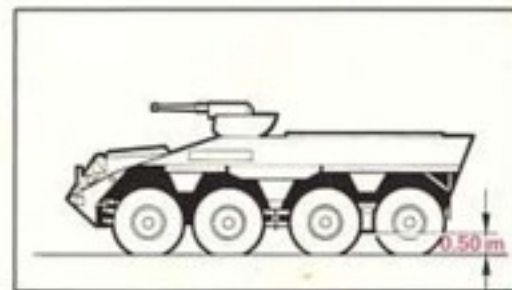
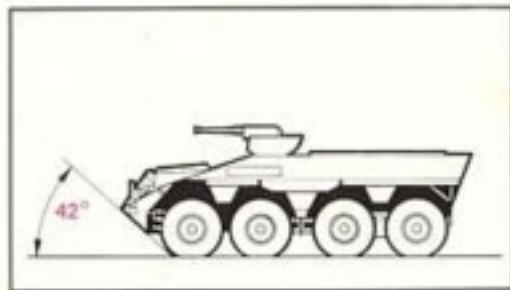
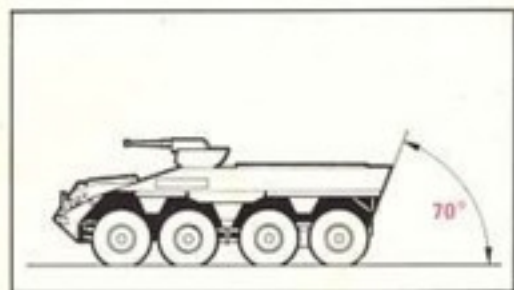

Electrical System

The electrical equipment is radio interference suppressed and dust and water-proof. A slave plug socket is provided, to enable the vehicle to be started from an outside source.

Voltage		24 Volts
Batteries	(excepting PWCO):	
	No. employed	two
	Amp/hr rating	100 Ah/20 hrs
Generator	(excepting PWCO):	
	Output	900 Watts
	Max. charging current	38 Amps

Steering

For easy steering in all conditions, both forward axles are steerable. Hydraulic power steering is employed. A steering indicator is provided to enable the driver to check the position of the front wheels.

Brakes

The following means are employed to brake the vehicle:

- Air-hydraulic service brakes operating on all eight wheels. The brake system is divided into two circuits from the two air-hydraulic brake units on-wards. The braking pressure is transmitted from the air-hydraulic brake units directly to the wheel cylinders.
- A handbrake acting mechanically on the brake drums fitted on the propeller shaft to the rear wheels behind the two transfer cases on either side of the auxiliary gearbox.
- An air-actuated parking brake, operated by means of a lever to the right of the steering wheel.
- An engine exhaust brake.

Transmission and Suspension

Following the experience obtained with thousands of DAF YA 328 cross-country vehicles, a transmission and suspension almost identical to those of the YA 328 were adopted for the DAF YP 408. The wheels are linked up by the unique "H" drive, thus eliminating any risk of wheel slip.

The engine power is transmitted from the main gearbox to the auxiliary gearbox through a short propeller shaft. A central differential is incorporated in the auxiliary box.

On the left and right of the auxiliary gearbox are the transfer cases from which the power is transmitted to the final drive boxes at the front and rear wheels. The front wheel drive engaging mechanism is fitted in the transfer cases.

Reduction ratios:

- 5-speed synchromesh gearbox
 - 1st gear 5.64 : 1
 - 2nd gear 3.08 : 1
 - 3rd gear 1.74 : 1
 - 4th gear 1 : 1
 - 5th gear 0.82 : 1
 - Reverse 5.06 : 1
- Auxiliary gearbox, "High" 1.214 : 1
"Low" 2.706 : 1
- Transfer cases 1.06 : 1
- Final drive boxes (worm gears) 5.20 : 1

The second front axle is steerable but not driven. The foremost front wheels are independently suspended on two trailing arms with transverse torsion bars. The wheels of the second front axle are likewise independently suspended, but the torsion bars are mounted longitudinally for reasons of space. The rear tandem axle consists of a centre axle with equalising beams and leaf springs. Vertical movement of the equalising beams is restricted by steel cables between the beams and the vehicle hull.



Wheels and Tyres

The vehicle is equipped with eight 11.00 x 20 combat tyres. Compared with conventional tyres, these combat tyres have reinforced sidewalls and a bead spacer between the bead heels.

If one or more tyres are punctured, the vehicle can be driven at a moderate speed for at least another 50 km.

In an emergency, when one of the tyres of the first front axle or rear tandem axle has a puncture, a wheel from the second front axle can be used as a spare. The wheel with the punctured tyre is then fitted on the second front axle and suspended from the hull with a special chain to keep it clear of the ground.

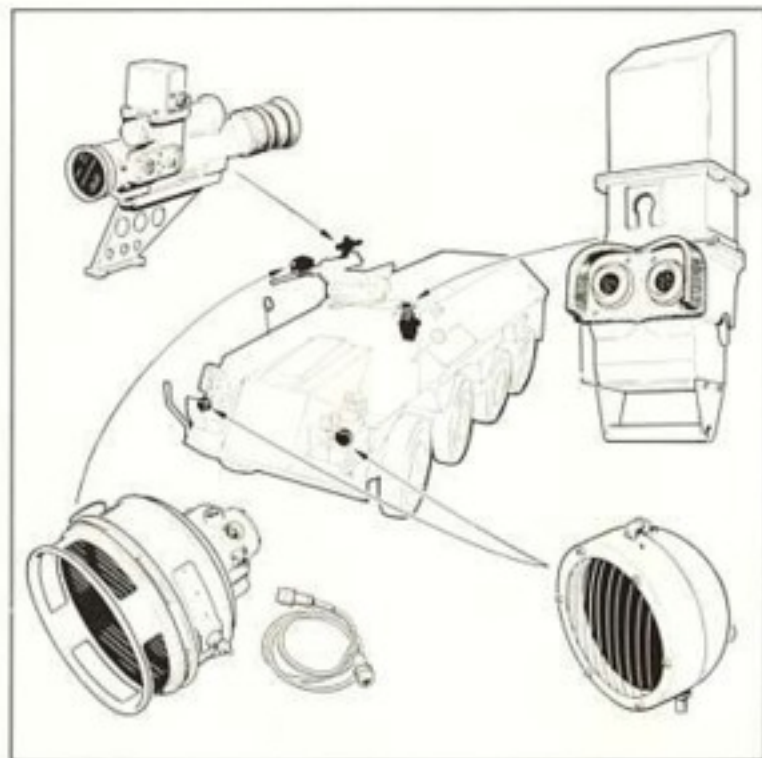

Night Vision

The driver's daylight periscope can be exchanged for a binocular infra-red periscope with a field of view of 46° . This infra-red periscope likewise rotates through 360° . Night driving without visible illumination is possible when infra-red headlamps are used in conjunction with the infra-red periscope.

The .50 machine gun can be equipped with an infra-red weapon sight having a magnification of 3.2 and a field of view of 14° . Together with an infra-red searchlight of 22 cm diameter on the gun mounting, this infra-red weapon sight makes aimed firing in darkness possible.

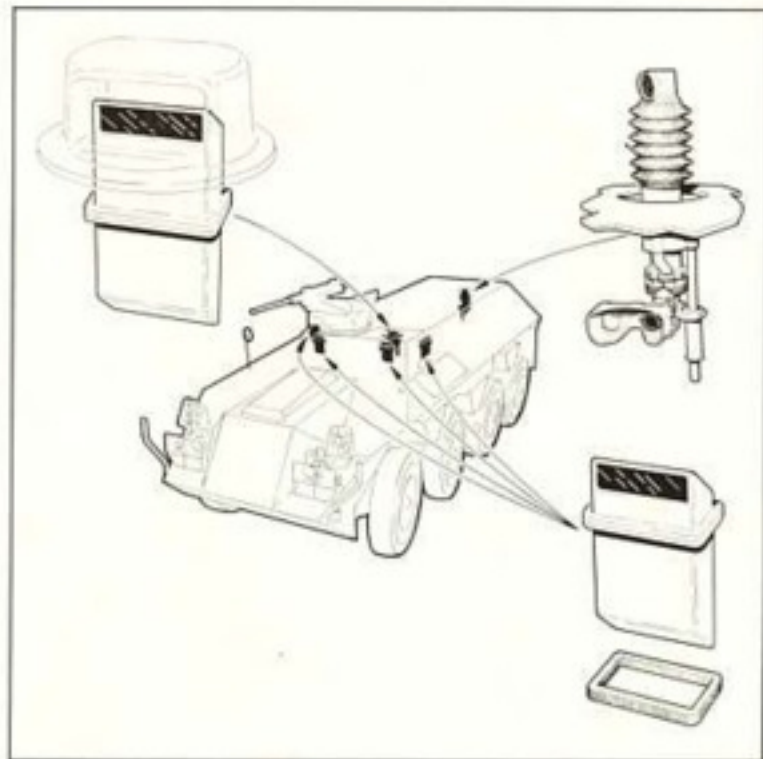

Optical Instruments - Day Vision

With closed hatches the area in front of the vehicle can be observed by the driver and co-driver through four fixed periscopes in the hull.

The driver also has a periscope rotating through 360° , with an elevation range of -12° to $+16^\circ$.

In the PWI-S (PC) and PWCO versions a panoramic periscope is also provided in the roof for the commander. This periscope (magnification x 3) rotates through 360° and has a field of view of 15° and an elevation range of -10° to $+10^\circ$.

A box for the storage of five spare periscopes is provided in the driver's compartment.

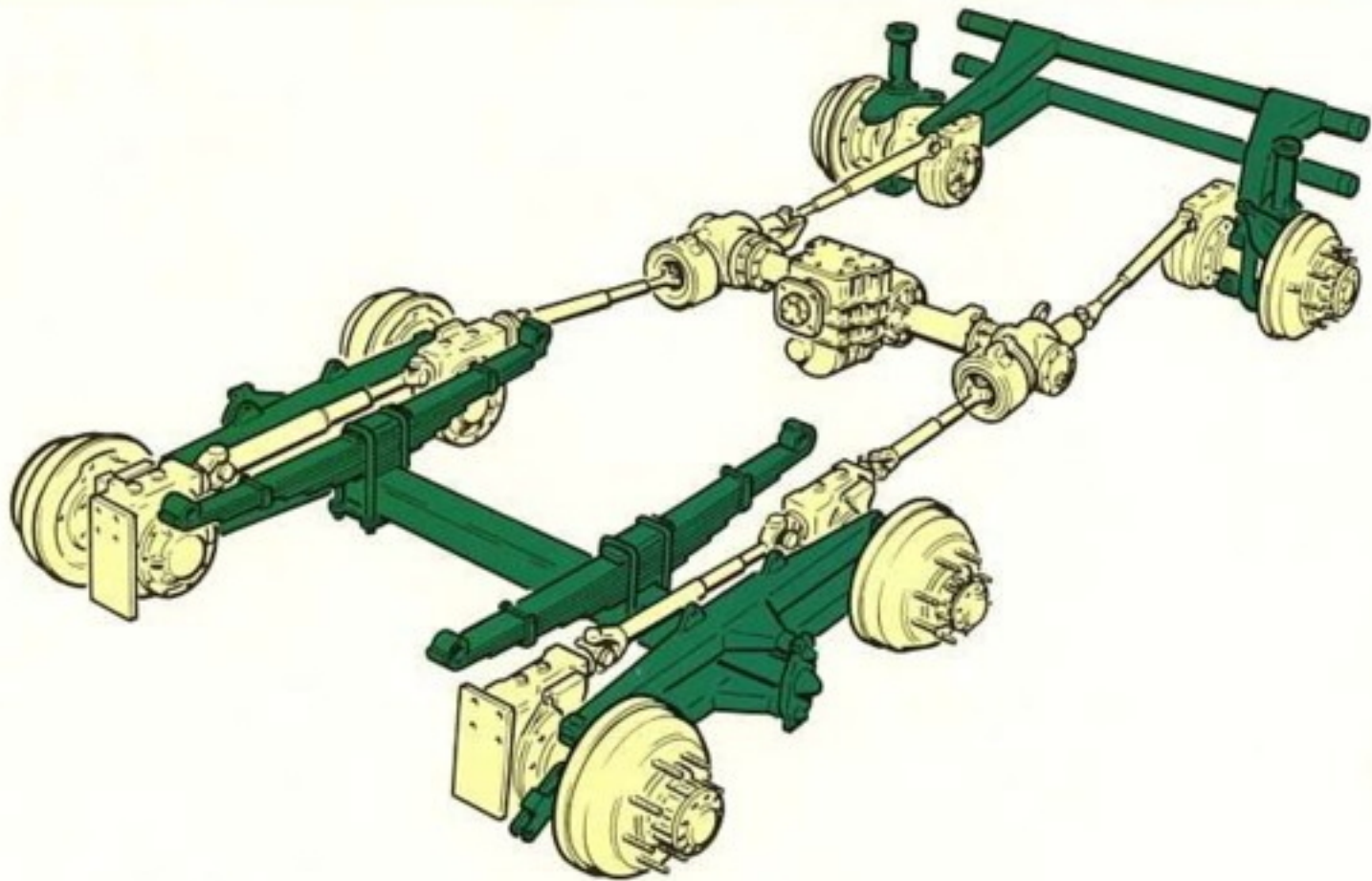

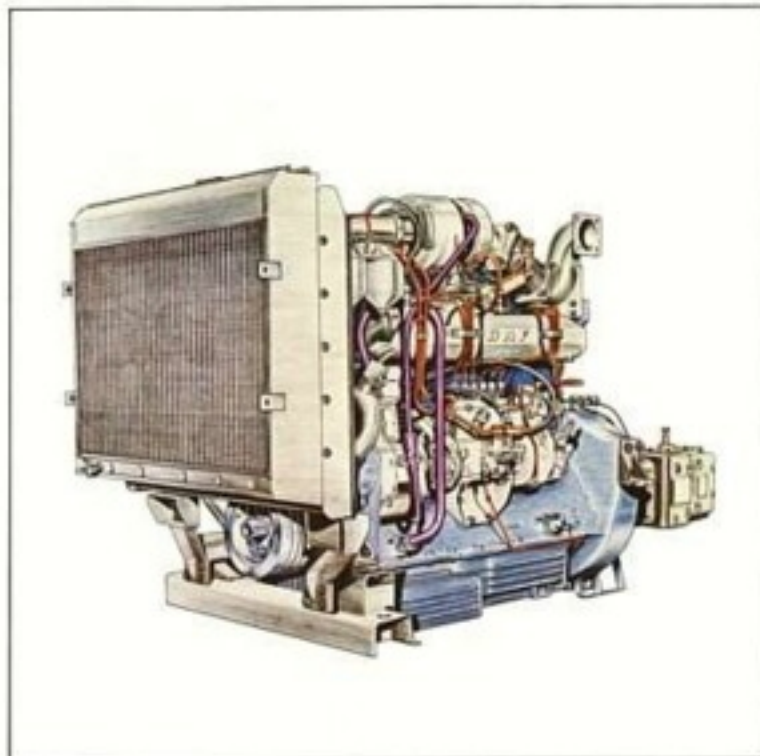

Engine

The DAF DS 575 diesel engine, which is fitted in large numbers to a wide range of civilian and military vehicles, has the following basic features:

- Utmost reliability
- Long life
- Favourable power to weight ratio
- Fuel economy

The engine is provided with a device enabling the driver to close off the crankcase ventilation without leaving his seat. This is necessary whenever there is a risk of water entering the engine when fording stretches of water. Closing off the crankcase ventilation system creates overpressure in the crankcase. An engine-driven air compressor supplies air for the air brake system. It can also be used to inflate the tyres.

Data

Make	: DAF
Designation	: DS 575
Type	: water-cooled, direct-injection, turbocharged diesel
No. of cylinders	: 6 in line
Bore and stroke	: 100.62 x 120.65 mm
Swept volume	: 5.753 litres
Compression ratio	: 16 : 1
Max. output (SAE)	: 165 hp at 2400 rpm
Max. torque (SAE)	: 52 kgm at 1800 rpm
Weight	
incl. accessories	: 570 kg

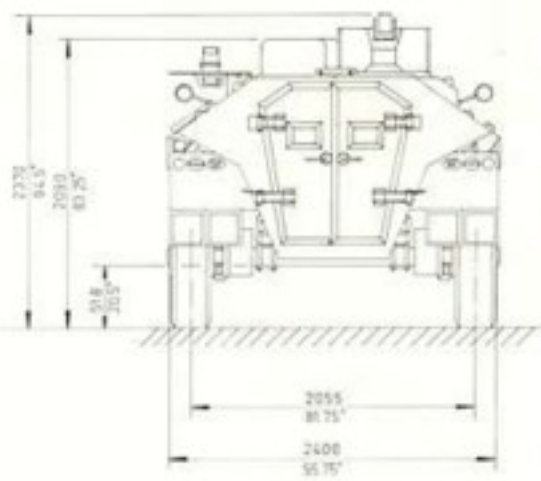
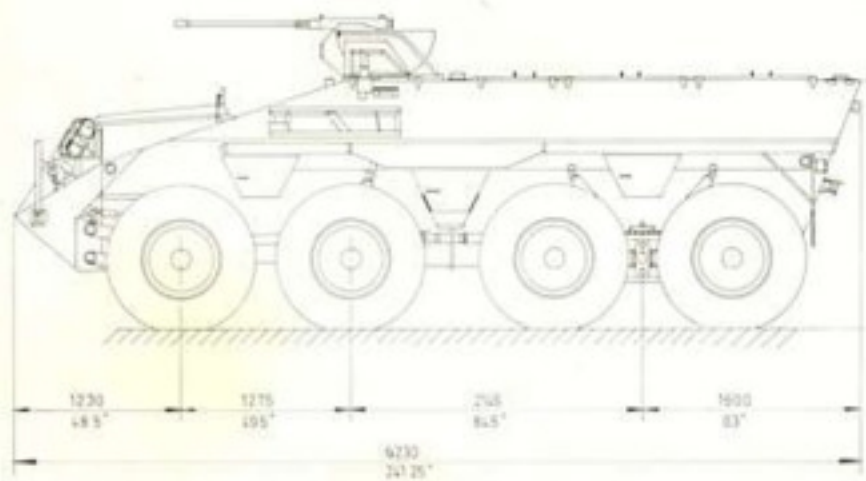



VAN DOORNE'S AUTOMOBIELFABRIEKEN N.V. / VAN DOORNE'S AANHANGWAGENFABRIEK N.V. EINDHOVEN - HOLLAND



